



Part no.: 50113666  
**AMS 300i 120 H**  
Optical distance sensor



**RS232**

**RS422**



CDRH



Figure can vary

## Contents

- . Technical data
- . Dimensioned drawings
- . Electrical connection
- . Operation and display
- . Part number code
- . Accessories
- . Notes

Part no.: 50113666 – AMS 300i 120 H – Optical distance sensor

## Technical data

<b>Basic data</b>	
Series	AMS 300i
Application	Positioning of electroplating plants Positioning of high-bay storage devices Positioning of skilnet systems and side-tracking skates Collision protection of cranes / gantry cranes
<b>Functions</b>	
Functions	Heating
<b>Characteristic parameters</b>	
MTTF	48 years
<b>Optical data</b>	
Light source	Laser, Red
Laser class	2, IEC/EN 60825-1:2007
<b>Measurement data</b>	
Measurement range	200 ... 120,000 mm
Absolute measurement accuracy	2 mm
Reproducibility (3 sigma)	1.5 mm
Max. traverse rate	10 m/s
<b>Electrical data</b>	
<b>Performance data</b>	
Supply voltage	18 ... 30 V, DC
<b>Interface</b>	
Type	RS 232, RS 422
<b>RS 232</b>	
Transmission speed	19,200 ... 115,200 Bd
<b>RS 422</b>	
Transmission speed	19,200 ... 115,200 Bd
<b>Connection</b>	
Number of connections	3 Piece(s)
<b>Connection 1</b>	
Type of connection	Connector
Designation on device	BUS IN
Function	Data interface BUS IN
Thread size	M12
Type	Male
No. of pins	5 -pin
Encoding	B-coded

**Part no.: 50113666 – AMS 300i 120 H – Optical distance sensor**
**Connection 3**

Type of connection	Connector
Designation on device	PWR
Function	PWR / SW IN/OUT Voltage supply
Thread size	M12
Type	Male
No. of pins	5 -pin
Encoding	A-coded

**Connection 4**

Type of connection	Connector
Designation on device	SERVICE
Function	Service interface
Thread size	M12
Type	Female
No. of pins	5 -pin
Encoding	A-coded

**Mechanical data**

Design	Cubic
Dimension (W x H x L)	84 mm x 166.5 mm x 159 mm
Housing material	Metal
Net weight	2,450 g
Type of fastening	Through-hole mounting

**Operation and display**

Type of display	LED LC Display
Operational controls	Membrane keyboard

**Environmental data**

Ambient temperature, operation	-30 ... 50 °C
Ambient temperature, storage	-30 ... 70 °C
Relative humidity (non-condensing)	90 %

**Certifications**

Degree of protection	IP 65
Protection class	III
Certifications	c UL US

**Classification**

eCl@ss 8.0	27270801
eCl@ss 9.0	27270801
ETIM 5.0	EC001825

## Dimensioned drawings

All dimensions in millimeters

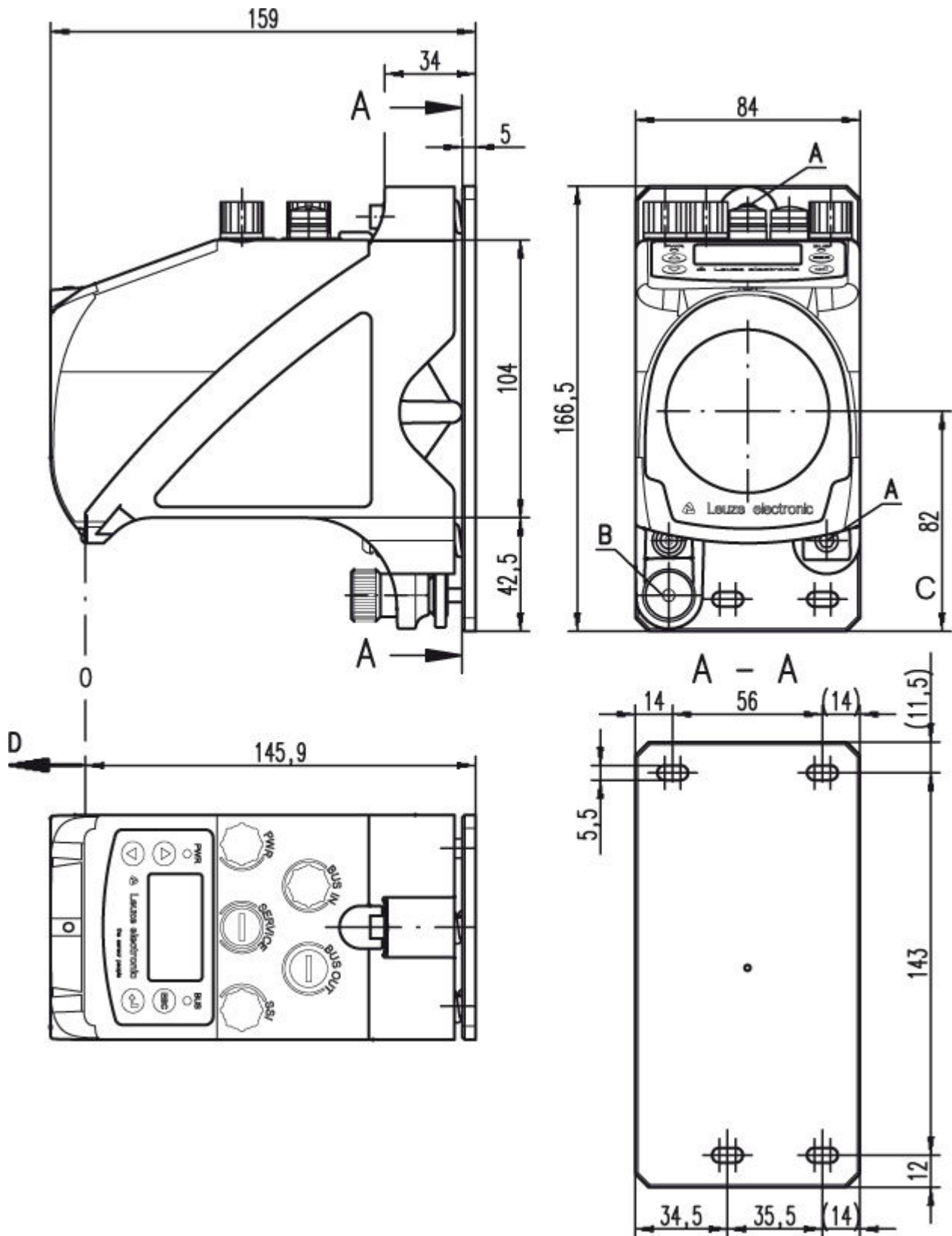

- A M 5 screw for alignment
- B Knurled nut with WAF 4 hexagon socket and M 5 nut for securing
- C Optical axis
- D Zero point of the distance to be measured

## Electrical connection

Connection 1	BUS IN
Type of connection	Connector
Function	Data interface BUS IN
Thread size	M12
Type	Male
Material	Metal
No. of pins	5 -pin
Encoding	B-coded

Pin	Pin assignment
1	NC
2	TXD
3	GND ISO
4	NC
5	RxD

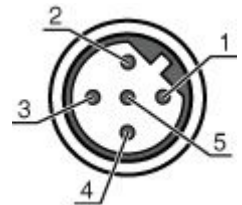

Connection 3	PWR
Type of connection	Connector
Function	PWR / SW IN/OUT Voltage supply
Thread size	M12
Type	Male
Material	Metal
No. of pins	5 -pin
Encoding	A-coded

Pin	Pin assignment
1	VIN
2	I/O 1
3	GND
4	I/O 2
5	FE

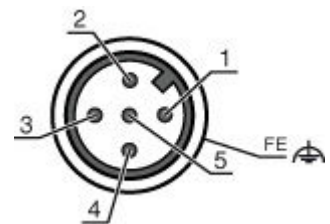

Connection 4	SERVICE
Type of connection	Connector
Function	Service interface
Thread size	M12
Type	Female
Material	Metal
No. of pins	5 -pin
Encoding	A-coded

Part no.: 50113666 – AMS 300i 120 H – Optical distance sensor

Pin	Pin assignment
1	n.c.
2	RS 232-TX
3	GND
4	RS 232-RX
5	n.c.

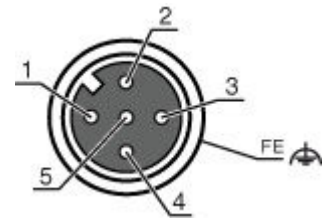

## Operation and display

### LEDs

LED	Display	Meaning	
1	PWR	Off	No supply voltage
		Green, flashing	Voltage connected / no measurement value output / initialization running
		Green, continuous light	Device OK, measurement value output
		Red, flashing	Device OK, warning set
		Red, continuous light	No measurement value output
2	BUS	Green, flashing	Device ok, initialization phase
		Green, continuous light	Data transmission active









## Part number code

Part designation: **AMS 3XXi YYY Z AAA**

AMS	<b>Operating principle:</b> AMS: absolute measurement system
3XXi	<b>Series/interface (integrated fieldbus technology)::</b> 300i: RS 422/RS 232 301i: RS 485 304i: PROFIBUS DP / SSI 308i: TCP/IP 335i: CANopen 338i: EtherCAT 348i: PROFINET RT 355i: DeviceNet 358i: EtherNet/IP 384i: Interbus
YYY	<b>Operating range:</b> 40: max. operating range in m 120: max. operating range in m 200: max. operating range in m 300: max. operating range in m
Z	<b>Special equipment:</b> H: with heating
AAA	<b>Interface:</b> SSI: with SSI interface



## Accessories

### Connection technology - Connection cables

	Part no.	Designation	Article	Description
	50104170	KB SSI/ IBS-10000-BA	Interconnection cable	Suitable for interface: SSI, Interbus-S Connection 1: Connector, M12, Axial, Female, B-coded, 5 -pin Connection 2: Open end Shielded: Yes Cable length: 10,000 mm Sheathing material: PUR
	50104169	KB SSI/ IBS-15000-BA	Interconnection cable	Suitable for interface: SSI, Interbus-S Connection 1: Connector, M12, Axial, Female, B-coded, 5 -pin Connection 2: Open end Shielded: Yes Cable length: 15,000 mm Sheathing material: PUR
	50104172	KB SSI/ IBS-2000-BA	Interconnection cable	Suitable for interface: SSI, Interbus-S Connection 1: Connector, M12, Axial, Female, B-coded, 5 -pin Connection 2: Open end Shielded: Yes Cable length: 2,000 mm Sheathing material: PUR
	50108446	KB SSI/ IBS-30000-BA	Interconnection cable	Suitable for interface: SSI, Interbus-S Connection 1: Connector, M12, Axial, Female, B-coded, 5 -pin Connection 2: Open end Shielded: Yes Cable length: 30,000 mm Sheathing material: PUR
	50104171	KB SSI/ IBS-5000-BA	Interconnection cable	Suitable for interface: SSI, Interbus-S Connection 1: Connector, M12, Axial, Female, B-coded, 5 -pin Connection 2: Open end Shielded: Yes Cable length: 5,000 mm Sheathing material: PUR
	50132077	KD U-M12-5A- V1-020	Connection cable	Connection 1: Connector, M12, Axial, Female, A-coded, 5 -pin Connection 2: Open end Shielded: No Cable length: 2,000 mm Sheathing material: PVC
	50132079	KD U-M12-5A- V1-050	Connection cable	Connection 1: Connector, M12, Axial, Female, A-coded, 5 -pin Connection 2: Open end Shielded: No Cable length: 5,000 mm Sheathing material: PVC
	50132080	KD U-M12-5A- V1-100	Connection cable	Connection 1: Connector, M12, Axial, Female, A-coded, 5 -pin Connection 2: Open end Shielded: No Cable length: 10,000 mm Sheathing material: PVC

Part no.: 50113666 – AMS 300i 120 H – Optical distance sensor





## Connection technology - Connectors

	Part no.	Designation	Article	Description
	50040097	KD 01-5-BA	Connector	Connection: Connector, M12, Axial, Female, A-coded, 5 -pin
	50038538	KD 02-5-BA	Connector	Suitable for interface: PROFIBUS DP, MultiNet Plus Connection: Connector, M12, Axial, Female, B-coded, 5 -pin





## Mounting technology - Other

	Part no.	Designation	Article	Description
	50107255	MW OMS/AMS 01	Mounting bracket	Design of mounting device: Angle, L-shape Mounting bracket, at system: Through-hole mounting Mounting bracket, at device: Screw type Material: Metal



## Reflective tapes for distance sensors

	Part no.	Designation	Article	Description
	50115020	Reflexfolie 200x200mm-H	Reflector	Special design: Heating Supply voltage: 230 V, AC Design: Rectangular Reflective surface: 200 mm x 200 mm Base material: Aluminum composite Fastening: Mounting plate, Through-hole mounting
	50104364	Reflexfolie 200x200mm-M	Reflector	Design: Rectangular Reflective surface: 200 mm x 200 mm Base material: Aluminum composite Fastening: Through-hole mounting, Mounting plate
	50104361	Reflexfolie 200x200mm-S	Reflective tape	Design: Rectangular Reflective surface: 200 mm x 200 mm Chemical designation of the material: PMMA Fastening: Adhesive
	50115021	Reflexfolie 500x500mm-H	Reflector	Supply voltage: 230 V, AC Design: Rectangular Reflective surface: 500 mm x 500 mm Base material: Aluminum Fastening: Mounting plate, Through-hole mounting Special design: Heating
	50104365	Reflexfolie 500x500mm-M	Reflector	Design: Rectangular Reflective surface: 500 mm x 500 mm Base material: Aluminum composite Fastening: Through-hole mounting, Mounting plate

**Part no.: 50113666 – AMS 300i 120 H – Optical distance sensor**

	Part no.	Designation	Article	Description
	50104362	Reflexfolie 500x500mm-S	Reflective tape	Design: Rectangular Reflective surface: 500 mm x 500 mm Chemical designation of the material: PMMA Fastening: Adhesive
	50104363	Reflexfolie 749x914mm-S	Reflective tape	Design: Rectangular Reflective surface: 749 mm x 914 mm Chemical designation of the material: PMMA Fastening: Adhesive
	50115022	Reflexfolie 914x914mm-H	Reflector	Special design: Heating Supply voltage: 230 V, AC Design: Rectangular Reflective surface: 914 mm x 914 mm Base material: Aluminum composite Fastening: Mounting plate, Through-hole mounting
	50104366	Reflexfolie 914x914mm-M	Reflector	Design: Rectangular Reflective surface: 914 mm x 914 mm Base material: Aluminum Fastening: Through-hole mounting, Mounting plate
	50108988	Reflexfolie 914x914mm-S	Reflective tape	Design: Rectangular Reflective surface: 914 mm x 914 mm Chemical designation of the material: PMMA Fastening: Adhesive

**Deflecting mirror**

	Part no.	Designation	Article	Description
	50035630	US 1 OMS	Deflecting mirror	Type of fastening: Screw type
	50104479	US AMS 01	Deflecting mirror	Type of fastening: Through-hole mounting

**Notes**

Observe intended use!
<ul style="list-style-type: none"> <li>• This product is not a safety sensor and is not intended as personnel protection.</li> <li>• The product may only be put into operation by competent persons.</li> <li>• Only use the product in accordance with its intended use.</li> </ul>

**WARNING! LASER RADIATION – LASER CLASS 2****Never look directly into the beam!**

The device satisfies the requirements of IEC 60825-1:2007 (EN 60825-1:2007) safety regulations for a product of **laser class 2** as well as the U.S. 21 CFR 1040.10 regulations with deviations corresponding to "Laser Notice No. 50" from June 24, 2007.

- Never look directly into the laser beam or in the direction of reflected laser beams! If you look into the beam path over a longer time period, there is a risk of injury to the retina.
- Do not point the laser beam of the device at persons!
- Interrupt the laser beam using a non-transparent, non-reflective object if the laser beam is accidentally directed towards a person.
- When mounting and aligning the device, avoid reflections of the laser beam off reflective surfaces!
- CAUTION! Use of controls or adjustments or performance of procedures other than specified herein may result in hazardous light exposure.
- Observe the applicable statutory and local laser protection regulations.
- The device must not be tampered with and must not be changed in any way.  
There are no user-serviceable parts inside the device.  
Repairs must only be performed by Leuze electronic GmbH + Co. KG.

**NOTE****Affix laser information and warning signs!**

Laser information and warning signs are affixed to the device. In addition, self-adhesive laser information and warning signs (stick-on labels) are supplied in several languages.

- Affix the laser information sheet to the device in the language appropriate for the place of use. When using the device in the US, use the stick-on label with the "Complies with 21 CFR 1040.10" note.
- Affix the laser information and warning signs near the device if no signs are attached to the device (e.g. because the device is too small) or if the attached laser information and warning signs are concealed due to the installation position.
- Affix the laser information and warning signs so that they are legible without exposing the reader to the laser radiation of the device or other optical radiation.

- For UL applications, use is only permitted in Class 2 circuits in accordance with the NEC (National Electric Code).
- Use as safety-related component within the safety function is possible, if the component combination is designed correspondingly by the machine manufacturer.